

Evolution[®] Engines 40GX

USER GUIDE



E[®]
EVOLUTION

Before using this engine, please read these instructions carefully.

Introduction

Congratulations on your purchase of the newest and one of the most technically advanced 2-stroke gas model airplane engines in the world. Whether you are new to the sport of model aviation or an experienced flier, you will enjoy the features of the new Evolution GX engine. Evolution engines are designed to be the most powerful in their class, extremely easy to start and operate, and provide years of enjoyable service. These engines incorporate many unique design features that ensure success with your new engine. This user's guide is intended to provide the basic information required to operate and maintain your Evolution GX engine.

Important: *While the Evolution engine is extremely easy to operate, if this is your first experience flying a model airplane, it is highly recommended that you have the help of an experienced modeler during the first few flights. Your local hobby shop or flying club can put you in touch with an experienced pilot in your area.*

Warranty Period

Exclusive Warranty- Horizon Hobby, Inc., (Horizon) warrants that the Products purchased (the "Product") will be free from defects in materials and workmanship for a period of 2 years from the date of purchase by the Purchaser.

Limited Warranty

(a) This warranty is limited to the original Purchaser ("Purchaser") and is not transferable. REPAIR OR REPLACEMENT AS PROVIDED UNDER THIS WARRANTY IS THE EXCLUSIVE REMEDY OF THE PURCHASER. This warranty covers only those Products purchased from an authorized Horizon dealer. Third party transactions are not covered by this warranty. Proof of purchase is required for warranty claims. Further, Horizon reserves the right to change or modify this warranty without notice and disclaims all other warranties, express or implied.

(b) Limitations- HORIZON MAKES NO WARRANTY OR REPRESENTATION, EXPRESS OR IMPLIED, ABOUT NON-INFRINGEMENT, MERCHANTABILITY OR FITNESS FOR A PARTICULAR PURPOSE OF THE PRODUCT. THE PURCHASER ACKNOWLEDGES THAT THEY ALONE HAVE DETERMINED THAT THE PRODUCT WILL SUITABLY MEET THE REQUIREMENTS OF THE PURCHASER'S INTENDED USE.

(c) Purchaser Remedy- Horizon's sole obligation hereunder shall be that Horizon will, at its option, (i) repair or (ii) replace, any Product determined by Horizon to be defective. In the event of a defect, these are the Purchaser's exclusive remedies. Horizon reserves the right to inspect any and all equipment involved in a warranty claim. Repair or replacement decisions are at the sole discretion of Horizon. This warranty does not cover cosmetic damage or damage due to acts of God, accident, misuse, abuse, negligence, commercial use, or modification of or to any part of the Product. This warranty does not cover damage due to improper installation, operation, maintenance, or attempted repair by anyone other than Horizon. Return of any goods by Purchaser must be approved in writing by Horizon before shipment.

Damage Limits

HORIZON SHALL NOT BE LIABLE FOR SPECIAL, INDIRECT OR CONSEQUENTIAL DAMAGES, LOSS OF PROFITS OR PRODUCTION OR COMMERCIAL LOSS IN ANY WAY CONNECTED WITH THE PRODUCT, WHETHER SUCH CLAIM IS BASED IN CONTRACT, WARRANTY, NEGLIGENCE, OR STRICT LIABILITY. Further, in no event shall the liability of Horizon exceed the individual price of the Product on which liability is asserted. As Horizon has no control over use, setup, final assembly, modification or misuse, no liability shall be assumed nor

accepted for any resulting damage or injury. By the act of use, setup or assembly, the user accepts all resulting liability.

If you as the Purchaser or user are not prepared to accept the liability associated with the use of this Product, you are advised to return this Product immediately in new and unused condition to the place of purchase.

LAW: These Terms are governed by Illinois law (without regard to conflict of law principals).

Safety Precautions

This is a sophisticated hobby Product and not a toy. It must be operated with caution and common sense and requires some basic mechanical ability. Failure to operate this Product in a safe and responsible manner could result in injury or damage to the Product or other property. This Product is not intended for use by children without direct adult supervision. The Product manual contains instructions for safety, operation and maintenance. It is essential to read and follow all the instructions and warnings in the manual, prior to assembly, setup or use, in order to operate correctly and avoid damage or injury.

Questions, Assistance, and Repairs

Your local hobby store and/or place of purchase cannot provide warranty support or repair. Once assembly, setup or use of the Product has been started, you must contact Horizon directly. This will enable Horizon to better answer your questions and service you in the event that you may need any assistance. For questions or assistance, please direct your email to productsupport@horizonhobby.com, or call 877.504.0233 toll free to speak to a service technician.

Inspection or Repairs

If this Product needs to be inspected or repaired, please call for a Return Merchandise Authorization (RMA). Pack the Product securely using a shipping carton. Please note that original boxes may be included, but are not designed to withstand the rigors of shipping without additional protection. Ship via a carrier that provides tracking and insurance for lost or damaged parcels, as Horizon is not responsible for merchandise until it arrives and is accepted at our facility. A Service Repair Request is available at www.horizonhobby.com on the "Support" tab. If you do not have internet access, please include a letter with your complete name, street address, email address and phone number where you can be reached during business days, your RMA number, a list of the included items, method of payment for any non-warranty expenses and a brief summary of the problem. Your original sales receipt must also be included for warranty con-

sideration. Be sure your name, address, and RMA number are clearly written on the outside of the shipping carton.

Warranty Inspection and Repairs
TO RECEIVE WARRANTY SERVICE, YOU MUST INCLUDE YOUR ORIGINAL SALES RECEIPT verifying the proof-of-purchase date. Provided warranty conditions have been met, your Product will be repaired or replaced free of charge. Repair or replacement decisions are at the sole discretion of Horizon Hobby.

Non-Warranty Repairs

Should your repair not be covered by warranty, the repair will be completed and payment will be required without notification or estimate of the expense unless the expense exceeds 50% of the retail purchase cost. By submitting the item for repair you are agreeing to payment of the repair without notification. Repair estimates are available upon request. You must include this request with your repair. Non-warranty repair estimates will be billed a minimum of ½ hour of labor. In addition you will be billed for return freight. Please advise us of your preferred method of payment. Horizon accepts money orders and cashiers checks, as well as Visa, Master Card, American Express, and Discover cards. If you choose to pay by credit card, please include your credit card number and expiration date. Any repair left unpaid or unclaimed after 90 days will be considered abandoned and will be disposed of accordingly. **Please note: non-warranty repair is only available on electronics and model engines.**

Electronics and engines requiring inspection or repair should be shipped to the following address:

Horizon Service Center
4105 Fieldstone Road
Champaign, Illinois 61822

All other Products requiring warranty inspection or repair should be shipped to the following address:

Horizon Product Support
4105 Fieldstone Road
Champaign, Illinois 61822

Please call 877-504-0233 with any questions or concerns regarding this product or warranty.

Mounting the Engine

Most model airplane designs make provision for an engine mount. It is extremely important that the engine mount be securely attached to the airplane's firewall and that the engine is securely fastened to the engine mount. Follow the instructions included with the airplane for mounting the engine.

The engine should be fastened in place with 4 screws through a conventional beam mount. Use 10x32 screws for the 40GX. If you decided to fasten the engine using a flexible motor mount, always choose parts with enough integrity and strength. Make sure all screws are tightened and regularly check that they are tight and in good condition.

Important: *Air is necessary to cool the engine during operation. Make sure that sufficient air circulation through the cowling is provided. As a basic reference, the outlet area should be 3-5 times the area of the inlet area to provide adequate cooling.*

Throttle Linkage

Carefully attach the throttle linkage to the engine using a ball link on the carburetor. Make sure that the linkage is free to operate from low throttle to high throttle and confirm that the low throttle setting on the transmitter closes the carburetor butterfly to the low idle position. Adjust the length of the pushrod until full throttle opens the carburetor butterfly fully, while low throttle, low trim completely closes the butterfly.

Attaching the Fuel Lines

Use large gasoline-compatible fuel line in the fuel tank as well as the supply line to the engine. Use 5/32 brass/copper fuel tubing to plumb the fuel tank. Be sure that the clunk inlet hole is of sufficient size to work with this size of large fuel tubing.

Selecting a Suitable Propeller

The Evolution 40GX has been designed to generate maximum power at 8000 rpm, according to the type of exhaust used. If you wish to utilize the maximum power output, choose a propeller, which will allow the engine to reach these revolutions, or slightly lower revolutions. (The engine will unload in the air depending on the aircraft speed and propeller selected.) We do not recommend using propellers that allow the engine to reach more than 8500 rpm on the ground.

Fuel for the Evolution Gas Engine

The Evolution gas engine has been designed to run on a mixture of high-quality 91 octane unleaded gasoline and synthetic oil intended for racing 2-stroke gasoline engines. For the break-in period of the new engine, mix the fuel in a ratio of 30 parts gasoline to 1 part ashless oil lubricant. The engine will require approximately 2 gallons of fuel for sufficient break in. Included with the engine is the ashless break-in oil. After break in, use a ratio of 40 parts gasoline to 1 part lubricant.

Suggested Propeller Dimensions

40GX	18x6	20x8	21x8
	18x8	20x10	21x10
	19x8	20x12	21x12

Evolution 40GX Ignition System

The 40GX uses an ignition system that can have the "battery test" function disabled or enabled. The engine comes with the ignition system battery test disabled. You can activate the ignition system "battery test" function by inserting the small red jumper provided in the ignition package. PLEASE READ THE INSTRUCTIONS ON ENABLING THE BATTERY TEST FUNCTION IF YOU WISH TO DO SO WITH YOUR IGNITION SYSTEM. Refer to page 8.

We recommend the use of a system power switch, or "kill switch," so that the ignition can safely be turned on and off. When you prepare to install the ignition in the aircraft, please check to make sure the ignition system battery test is "DISABLED" (the red jumper is not installed in the ignition).

CAUTION: IF YOU ENABLE THE BATTERY TEST FUNCTION, PLEASE READ THE FOLLOWING FOR YOUR OWN PROTECTION:

During the battery test, a series of flashes are generated and voltage is measured. This will cause a spark plug to be fired for up to 2 seconds to check the condition of the battery prior to starting the engine. If the engine is in the compressed position (i.e. the piston is above the exhaust port in either the up or down part of the stroke), any compressed fumes may ignite, causing the propeller to turn, and possibly the engine to start, unintentionally.

To prevent this with the Evolution Gasoline GX Ignition System, check to be sure the ignition system is turned off and that the piston is in the bottom dead center (BDC) position. Bottom Dead Center can be found by rotating the propeller through the compression stroke. As you rotate the propeller you will feel it tighten, then suddenly loosen. Once the turn becomes very easy, you have completed the compression stroke and are at BDC. Once you are sure the piston is in this position, you may turn on the ignition power switch and operate the system safely.

As always, it is important to use extreme care when near or with engines, fuel and propellers. Please use caution when working with these components. If you have any questions or concerns, please contact the Horizon Support team at 1-877-504-0233 or productsupport@horizonhobby.com.

Starting the Engine

Evolution Gas Engines come with a carburetor adjusted to a basic setting. This setting should be maintained during the initial break-in runs.

Before you first start the engine, make sure that the spark plug is screwed in and tightened and that the spark plug socket is fitted in place properly. Fix the ignition sensor in the proper position above the magnet with the screws enclosed. *Follow the instructions in the ignition system section to mount the ignition module in your model.

Important: *Never turn the engine over with the ignition turned on unless the spark plug is inserted in the spark plug socket. This could lead to ignition damage.*

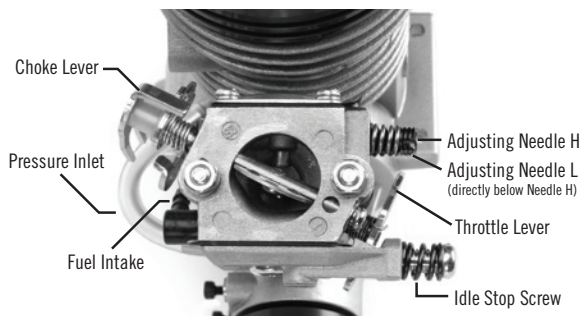

Basic setting: (minutes refer to the hands of a clock)

Carburetor Adjustments 40GX

Adjust needle (L) for low rpm range 1 turn and 30 minutes

Adjust needle (H) for high rpm 1 turn and 45 minutes

Note: *One of the features of the 40GX is the way the spring-loaded choke is activated and released open. With the throttle closed, rotate the choke closed and the choke linkage will engage the throttle lever and lock into the closed position. The choke will stay locked in place until the throttle lever is slightly opened, and then the choke will automatically disengage from the throttle lever.*

- 1) Be sure that the propeller nut is tight and that the spinner (if used) is secure and not touching the propeller blades. Check to be sure that the carburetor throttle is operating properly by turning on the radio and moving the throttle stick of the transmitter to low; the carb throttle butterfly blade should be closed completely. Now move the transmitter throttle to high and be sure the carb throttle butterfly blade opens up completely.
- 2) Have someone assist in holding the airplane. Close the choke completely so that the choke engages the throttle lever and remains closed. This also automatically sets a slightly high engine idle for starting the engine.
- 3) When you are ready to start the engine, switch the ignition on and, using an electric starter, begin to crank the engine over counterclockwise. The motor should fire or “pop” within a few seconds of applying the starter. At this point you have two choices of when to deactivate the choke.
 - a) As the engine “pops” and begins to run, you can blip the throttle slightly and this will disengage the choke lever and allow the choke to open completely; the engine should remain running. Allow the engine to run for 30–45 seconds and then adjust for a proper idle.
 - b) Allow the engine to “pop” and then stop running. Open the choke now by moving the throttle just above idle to disengage the choke lever. Set the throttle to the idle position (carb butterfly plate slightly open). Engage the electric starter to the engine again, and the engine should fire and be running at a fast idle. Allow the engine to run for 30–45 seconds and then adjust for a proper idle.
- 4) If the engine does not start even after using the starter to crank the engine a second time, open the throttle to maximum, turn off the ignition and turn the engine about 4 revolutions. Switch the ignition on again, then restart the engine with throttle at a fast idle position and the choke valve set open.
- 5) At this point if the engine still will not start, unscrew the spark plug and check its contacts. Clean any possible excess fuel (an indication of engine flooding) and screw it in again. Further starting should only be done with the throttle at idle position. If the plug is dry, then probably not enough fuel has been drawn into the carburetor. If that is the case, check the fuel feed and then return to the instructions given in paragraph 1 above.

After starting and warming the engine for 30–45 seconds, adjust as follows:

Step I- Move the throttle to 2/3 high throttle position quickly (fast acceleration), then repeat three times. If the engine accelerates smoothly go to Step III; if acceleration is not smooth go on to Step II.

Step II- Faulty acceleration and a tendency to quit is usually attributable to a poor fuel mixture in the medium rpm range. Stop the engine and recheck the fuel feed (the fuel line must not be pinched or broken). Restart the engine and test acceleration again. If the problem persists, adjust the carburetor. Open the low speed needle by 5 minutes and retest. If acceleration is smooth, open the needle by another 3–5 minutes—this should be done because the needle was previously set too lean; if atmospheric conditions changed recently you may have to re-adjust the needle.

If the engine continues not to accelerate properly, open the low speed needle by 10 minutes. If the engine's operation does not improve, shut it off and check the basic setting, restart the engine and test the acceleration. If the engine runs correctly, proceed to Step III.

Step III- If it continues to not accelerate properly, open the low speed needle by another 10 minutes. If acceleration is faulty, the defect is likely to lie somewhere other than an adjustment.

Step IV- If the engine accelerates correctly, according to the above test, set it at idle speed and accelerate to full speed. Repeat twice more. If the engine functions correctly, go to Step V. If it cuts out, open the low speed needle by 5–10 minutes more.

If the engine does not respond to acceleration fast enough, keep closing the low speed needle until it starts to cut out in response to throttle opening. At that point, reopen the low speed needle by 5–10 minutes.

Step V- If the engine reacts correctly, set it at full speed. If revolutions do not drop, the engine has been adjusted successfully. If revolutions seem to drop, open the high speed needle by about 5–10 minutes.

Caution! *The engine must be stopped while you adjust the carburetor in order to prevent injury by the propeller.*

Starting and running a new engine:

Having started the engine, leave it running for about 5 minutes at a higher idle speed. Then run it for about 20 minutes, while changing revolutions from idle to 1/2–3/4 of the range and shortly holding each position—gradually prolong the holding periods. After 10 minutes of operation, open the throttle to maximum for a period of about one minute. At this point, stop the engine and let it cool down. Then restart it and check the adjustment. If everything is all right, you can make your first flight. During the first few flights, do not overload the engine and do not let it run at high revolutions for long periods of time (very important during hot weather). After break in, fuel and oil should be mixed in the proportion 40:1.

Contents and Add-Ons

Engine
Spark Plug (EVO30013309)
Electronic Ignition (EVO3314LB)
Exhaust Gasket (EVO30983401)
Spark Plug Cable Spiral Wrap
Spark Plug Wrench
Break-in Oil
Instruction manual
Decal sheet (2 pcs)

Optional Items

Muffler Inverted Wraparound (EVO30983400)
Side Mounted (BISO5615)
Header (EVO30983269)
Tuned Silencer (EVO30983268)
Gas Start Kit (EVO1002)
Radial Mount (EVO30983398B)
Evolution 19x8 Propeller (EVO4001)
Ignition Battery 2-cell LiPo (THP21002SPL)

Troubleshooting Guide

If the Engine Does Not Start

- check and use a new spark plug if needed.
- check fuel lines.
- check for proper mechanical function by turning the engine over.
- check that the carburetor is correctly installed.
- remove the carburetor cover from the feed side; check the filter and blow off carburetor with compressed air (Caution: When using compressed air, use eye protection.); when re-assembling be careful to maintain the proper order of the components.
- check the vacuum feed line.

Mechanical Faults

If the engine cannot be turned over easily

- a likely cause is the piston in the cylinder is seized: loosen and unscrew the cylinder head bolts.
- carefully remove the cylinder liner.
- visually examine the piston and crankcase to find the likely cause of the engine's mechanical problem.

Note: *Mechanical repairs must always be completed by our professional service department.*

40GX Evolution Engine Dimensions

A mm	B mm	C mm	D mm	E mm
136	118	60	84	70
F mm	G mm	H mm	I mm	J mm
41	5.3	M10x1	10	46

40GX Evolution Engine Specifications

Evolution 40GX

Bore	38mm	Fuel	Unleaded (91 octane) gasoline
Stroke	35mm		
Displacement	39.7cc/2.42 cu in	Break In	Oil with gasoline in mixture 1:30
Weight of engine without ignition*	1451 g/3.19 lb	Lubrication	Oil with gasoline in mixture 1:40
Weight of ignition unit	190 g/6.7 oz		
RPM range	1400–9500 rpm		

* The value in the table above stands for the weight of a completely assembled engine, including the spark plug, carburetor, drive washer and prop screws.

Evolution GX Engine Simple Start Ignition System

The spark ignition included with your Evolution gas engine is a modern generation electronic ignition. There are many useful functions built into the microprocessor of this unit.

In addition to the basic ignition functions, the unit has a FAIL-SAFE feature: After 90 seconds of inactivity, it automatically switches to an inactive state. In order to resume normal operation, it is necessary to turn the battery switch off and then back on. This function will preserve battery life should the switch be left in the ON position during inactivity.

Installation of the GX Simple Start Ignition Unit

While installing the ignition unit in your model, be careful to have all parts that are connected to the unit and the engine situated as far as practical from the radio receiver and radio antenna. The throttle servo should be mounted a distance of 8–12 inches from the engine. The spark plug cable must not touch any part of the model structure as vibration may damage the cable. If this is not practical, it will be necessary to provide an insulation material for the cable. All components must be protected from contact with engine fuel.

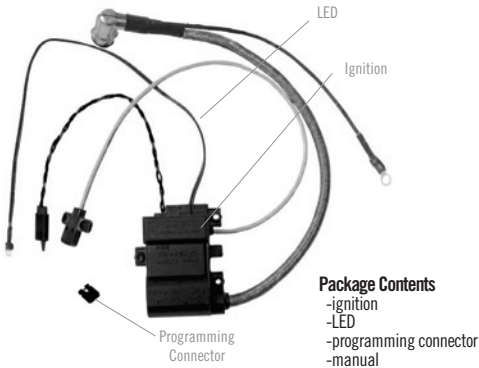

DESCRIPTION

The ICU-L ignition makes the selection of a pre-ignition curve ("short" or "long" exhaust stroke) possible. You can change the setting using the supplied programming connector.

The setting is permanently stored in the memory of the ignition even if the supply voltage is turned off. You do not need to change the setting when you turn the ignition on again.

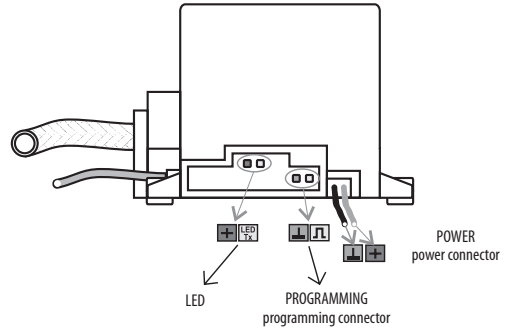

BASIC FEATURES

- Two preprogrammed pre-ignition curves ("short," which is the default setting, and "long," the tuned silencer)
- Sleep mode after 90 seconds of engine inactivity to save battery power
- Ignition shuts off if engine runs counterclockwise

Enabling or Disabling Battery Test

This ignition makes it possible to enable or disable the battery test. The battery test is very useful when Li-Po or Li-Ion batteries are used. During the test, a series of flashes are generated and voltage is measured. When the battery passes the test, that means it will run for a minimum of 10 minutes in flight.

- Battery test is disabled when jumper is removed and programming pins are open (this is the default condition of the engine as shipped from Evolution)

- Battery test is enabled when jumper is plugged and programming pins are closed

CAUTION: *With the battery test enabled the engine can unintentionally start during the testing process. Be sure to restrain the aircraft prior to turning the ignition on when using the battery test feature.*

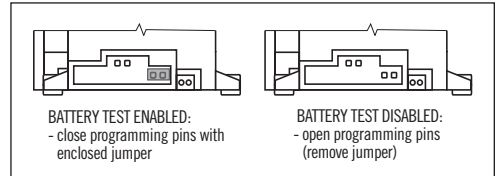

- Enable or disable battery test when the ignition is off

If you want to change the type of silencer, do the first two steps and then continue to PROGRAMMING SEQUENCE. Otherwise, follow these steps:

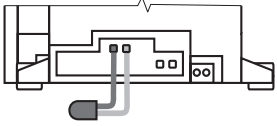
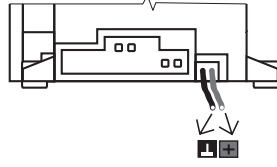
FIRST STEP	SECOND STEP	START
<ul style="list-style-type: none">- Screw on pickup on engine- Attach the plastic protection to the high voltage cable- Connect boot to plug- Mount ground terminal on the high-voltage cable bolt holding the engine to the motor mount- Mount the ignition to the airplane	<ul style="list-style-type: none">- Connect enclosed LED to the ignition (red or red/black wire to left) 	<ul style="list-style-type: none">- Keep clear of the propeller- Connect battery with the ignition box 

Starting Sequence

- Move propeller to put the piston at bottom dead center of its travel
- Keep your hands outside of the propeller radius to avoid serious injury
- Hold the airplane and switch on ignition
- If battery test is enabled, the ignition starts battery test; during this test, a series of sparks are generated for about 2 seconds and LED is blinking
- If battery test is disabled, then LED blinks for about 2 seconds
- If LED turns off, you can fly; otherwise battery is low

Programming Sequence

Changing the Ignition Timing

If using the battery test function

- Make sure plug cap is attached to the plug
- Turn on ignition and power up
- Wait about 90 seconds until sleep mode is active; LED will begin flashing once per second
- If battery test is enabled (jumper is plugged) remove the jumper from programming pins
- Wait about 3 seconds; a flashing sequence changes itself
- Unplug battery
- Plug jumper back (to enable battery test)

If not using the battery test function

- If battery test is disabled (jumper is removed), plug the jumper to programming pins
- Wait about 3 seconds until flashing sequence changes
- Unplug battery
- Unplug jumper back (to disable battery test)

To change silencer type, repeat the procedure again:
short muffler ⇨ tuned pipe ⇨ short muffler, etc.

WARNING! Use the ignition only in dry conditions

Use recommended number and type of cells for every ignition type

The product is specified for RC engines only (other use must be approved by the manufacturer)

Do not take off the plug cap if the ignition is on

Danger of electric injury (voltage over 20,000V)

Recharge ignition battery only outside the model

Because of possible interferences, ignition and battery should be placed at least 25 cm from the receiver

The manufacturer is not responsible for damages caused by not following the manual or by using the ignition for anything other than RC engines. Guarantee is void if the high voltage (HV) cable or HV isolation is damaged, the pickup or batteries are reversed, or the ignition box is opened.

LED Blinking Types

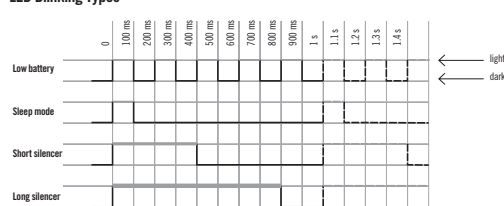

LED Blinking Indication

Type	Problem	Solution
One short flash per second	Sleep mode spark is blocked	Unplug battery and reconnect it again

Technical Data

Version	Lite
Weight	170 g
Power supply	2x Li-Ion/LiPo* 6x NiCd / NiMH* 5x NiCd / NiMH
Minimal battery voltage*	6.5V*
<i>Sleep mode after 90 seconds of engine inactivity</i>	
<i>Battery level signalization *</i>	
<i>Ignition goes off if engine runs counterclockwise</i>	
Choice of preignition curve	
Preignition point	5°
Location of the magnet	240° / 120°
Min. battery capacity	600mAh

* if battery test is enabled

Never use ignition with plug cap removed from plug! Before first flight, do a range check with running engine.

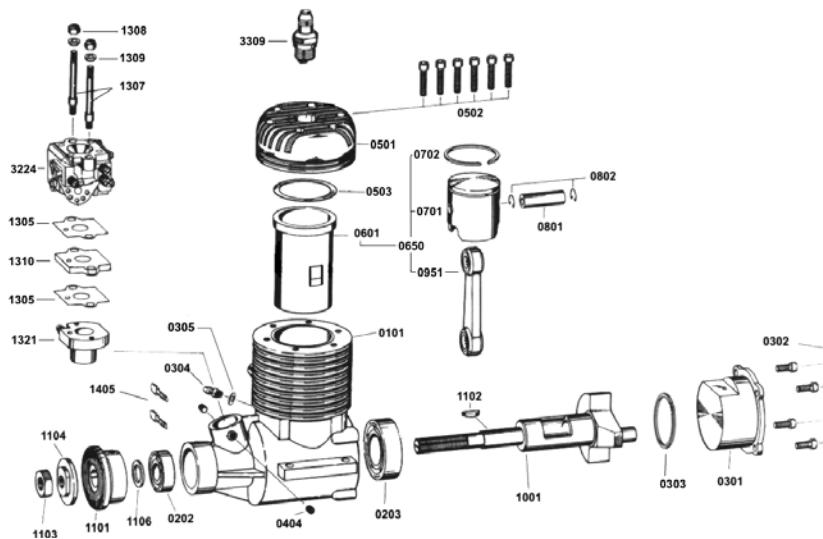

40GX

Part Number	Description	Part Number	Description
EVO30013309	Spark Plug NGK 5812 (sm cap)	EVO30950951	Connecting Rod
EVO30950101	Crankcase	EVO30981001	Crankshaft
EVO30980202	Front Bearing	EVO3098i1101	Drive Washer
EVO30980203	Rear Bearing	EVO30981102	Drive Washer Key
EVO30980301	Rear Cover	EVO30941103	Propeller Nut
EVO30980302	Rear Cover Screws - Set	EVO30941104	Propeller Washer
EVO30980303	Rear Cover O-Ring	EVO30981106	Washer
EVO30940304	Pressure Nozzle	EVO30941305	Carburetor Gasket (2pcs)
EVO30940305	Pressure Nozzle Gasket (2pcs)	EVO30941307	Carburetor Bolt (2pcs)
EVO30940404	Carburetor Screw (2pcs)	EVO30941308	Carburetor Nut (2pcs)
EVO30950501	Cylinder Head	EVO30941309	Carburetor Washer (2pcs)
EVO30980502	Cylinder Head Screws (6pcs)	EVO30941310	Thermo-Isolation Washer
EVO30950503	Cylinder Head Gasket (3pcs)	EVO30981321	Carburetor Flange
EVO30950601	Cylinder Liner	EVO3224L	Carburetor
EVO30950650	Cylinder Piston Assembly	EVO3314LB	GT2 Type Ignition ICU-L
EVO30950701	Piston	EVO30983401	Muffler Gasket
EVO30040702	Piston Ring	EVO30941405	Ignition Sensor Fixing Screws (2pcs)
EVO30040801	Piston Pin		
EVO30040802	Piston Pin Retainer		



© 2008 Manufactured exclusively for Horizon Hobby, Inc.
www.evolutionengines.com 877-504-0233

13612